

SOT-23

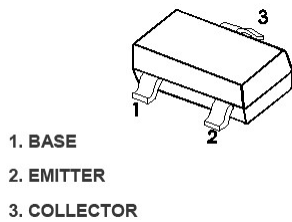

Marking: 2T1

特征 Features

- 最大功率耗散 300mW; Power Dissipation of 300mW
- 高稳定性和可靠性。High Stability and High Reliability

机械数据 Mechanical Data

- 封装: SOT-23 封装 SOT-23 Small Outline Plastic Package
- 环氧树脂 UL 易燃等级 Epoxy UL: 94V-0
- 安装位置: 任意 Mounting Position: Any

极限值和温度特性(TA = 25°C 除非另有规定)

Maximum Ratings & Thermal Characteristics (Ratings at 25°C ambient temperature unless otherwise specified.)

参数 Parameters	符号 Symbol	数值 Value	单位 Unit
Collector-Base Voltage	V _{CBO}	-40	V
Collector-Emitter Voltage	V _{CEO}	-25	V
Emitter -Base Voltage	V _{EBO}	-5	V
Collector Current-Continuous	I _C	-500	mA
Collector Power Dissipation	P _C	300	mW
Junction Temperature	T _j	150	°C
Storage Temperature	T _{stg}	-55-+150	°C
Thermal resistance From junction to ambient	R _{θJA}	416	°C/W

电特性 (TA = 25°C 除非另有规定)

Electrical Characteristics (Ratings at 25°C ambient temperature unless otherwise specified.)

参数 Parameter	符号 Symbols	测试条件 Test Condition	界限 Limits		单位 Unit
			Min	Max	
Collector-base breakdown voltage	V(BR)CBO	I _C =-100uA, I _E =0	-40		V
Collector-emitter breakdown voltage	V(BR)CEO	I _C =-1mA, I _B =0	-25		V
Emitter-base breakdown voltage	V(BR)EBO	I _E =-100uA, I _C =0	-5		V
Collector cut-off current	I _{CEO}	V _{CE} =-20V, I _B =0		-100	nA
Collector cut-off current	I _{CBO}	V _{CB} =-40V, I _E =0		-100	nA
Emitter cut-off current	I _{EBO}	V _{EB} =-5V, I _C =0		-100	nA
DC current gain	h _{FE}	V _{CE} =-1V, I _C =-50mA	120	400	
Collector-emitter saturation voltage	V _{CE(sat)}	I _C =-500mA, I _B =-50mA		-0.60	V
Base -emitter saturation voltage	V _{BE(sat)}	I _C =-500mA, I _B =-50mA		-1.20	V
Transition frequency	f _T	V _{CE} =-6V, I _C =-20mA, f=30MHz	150		MHz
Collector output capacitance	C _{ob}	V _{CB} =-10V, I _E =0, f=1MHz		5	pF

CLASSIFICATION OF h_{FE}(1)

RANK	L	H	J
RANGE	120-200	200-350	300-400

Typical characteristics

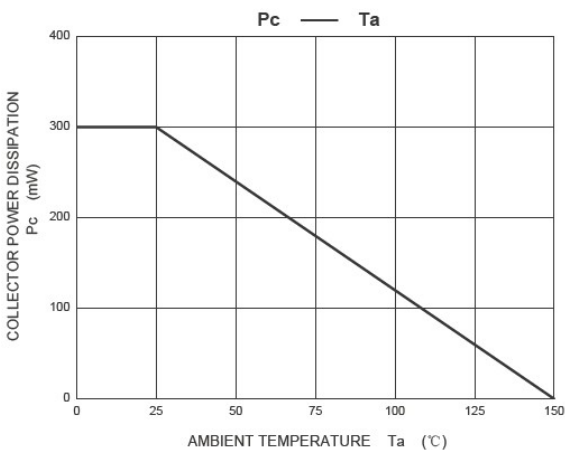
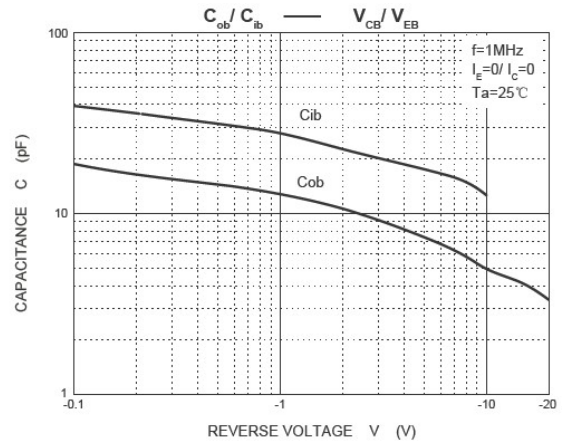
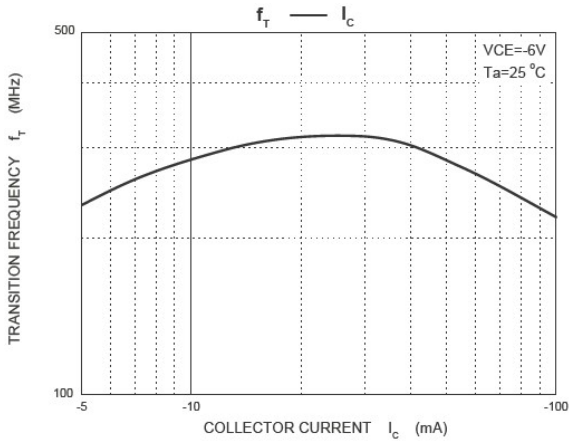
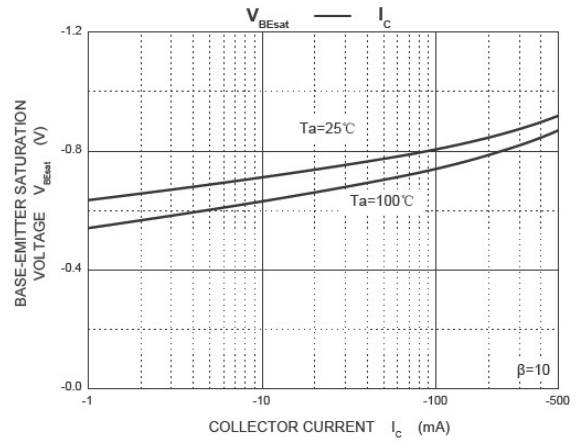
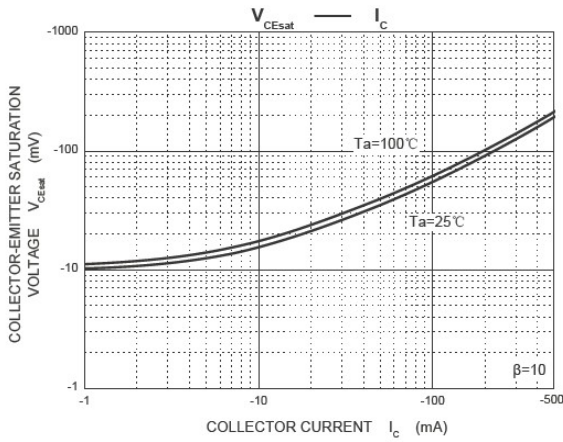
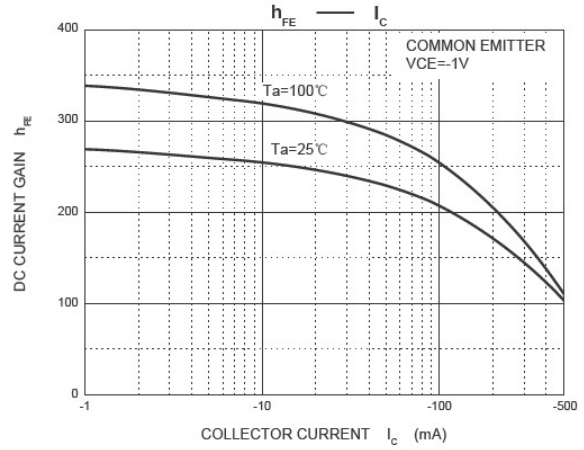
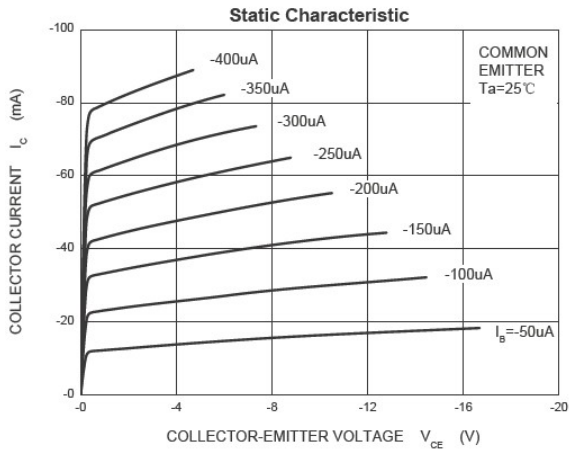

SOT-23 PACKAGE OUTLINE Plastic surface mounted package

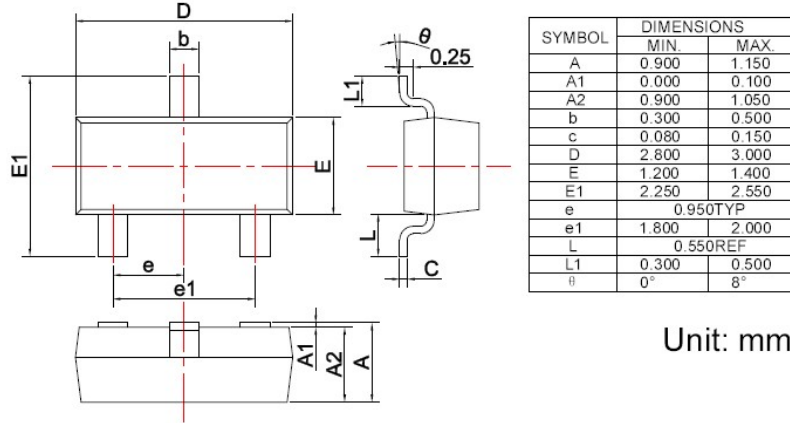

焊盘设计参考 Precautions: PCB Design

Recommended land dimensions for SOT-23 diode. Electrode patterns for PCBs

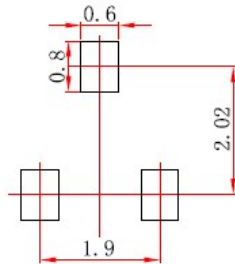

- Note:
1. Controlling dimension: In millimeters.
 2. General tolerance: $\pm 0.05\text{mm}$.
 3. The pad layout is for reference purposes only.

NOTICE

The information presented in this document is for reference only. Involving product optimization and productivity improvement, ChipNobo reserves the right to adjust product indicators and upgrade some technical parameters. ChipNobo is entitled to be exempted from liability for any delay or non-delivery of the information disclosure process that occurs.

本文件中提供的信息仅供参考。涉及产品优化和生产效率改善，ChipNobo 有权调整产品指标和部分技术参数的升级，所出现信息披露过程存在延后或者不能送达的情形，ChipNobo 有获免责权。

The product listed herein is designed to be used with residential and commercial equipment, and do not support sensitive items and specialized equipment in areas where sanctions do exist. ChipNobo Co., Ltd or anyone on its behalf, assumes no responsibility or liability for any damages resulting from improper use.

此处列出的产品旨在民用和商业设备上使用，不支持确有制裁地区的敏感项目和特殊设备，ChipNobo 有限公司或其代表，对因不当使用而造成的任何损害不承担任何责任。

For additional information, please visit our website <http://www.chipnobo.com>, or consult your nearest Chipnobo sales office for further assistance.

欲了解更多信息，请访问我们的网站 <http://www.chipnobo.com>，或咨询离您最近的 Chipnobo 销售办事处以获得进一步帮助。